



The Hunter Douglas® 2 years Quality Guarantee is an expression of our desire to provide a thoroughly satisfying experience when selecting, purchasing and living with your window fashion products.

COVERED :

- Defects in materials, workmanship or failure in assembling.
- Internal mechanisms (components and brackets).
- Repairs and/or replacements will be made with like or similar parts or products.
- Labor and transportation within 2 years guarantee.
- Motorization components are covered for 2 years from the date of purchase.

NOT COVERED :

- Any conditions caused by normal wear and tear.
- Abuse, accidents, misuse or alterations to the product.
- Exposure to the elements (sun damage, wind, water/moisture) and discoloration or fading over time.
- Failure to follow our instructions with respect to measurement, proper installation, cleaning or maintenance.

Please contact with your local dealer for warranty service.

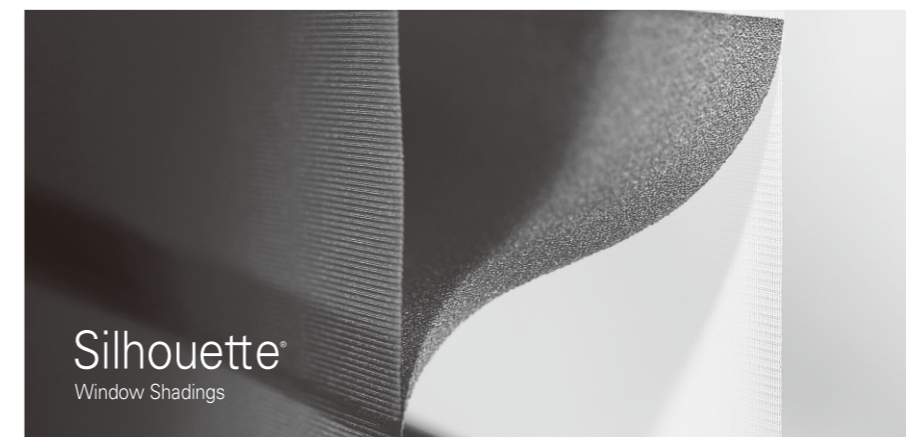

Pirouette® Window Shadings

OPERATION 3-5
CLEANING 6
CHARACTERISTICS 7

Silhouette® Window Shadings

OPERATION 9-12
CLEANING 13-14
CHARACTERISTICS 15-16

Thanks for choosing Hunter Douglas, Correct operation and cleaning will maintain your window coverings beauty and functions well.



Pirouette®

Window Shadings

EasyRise™ UltraGlide®

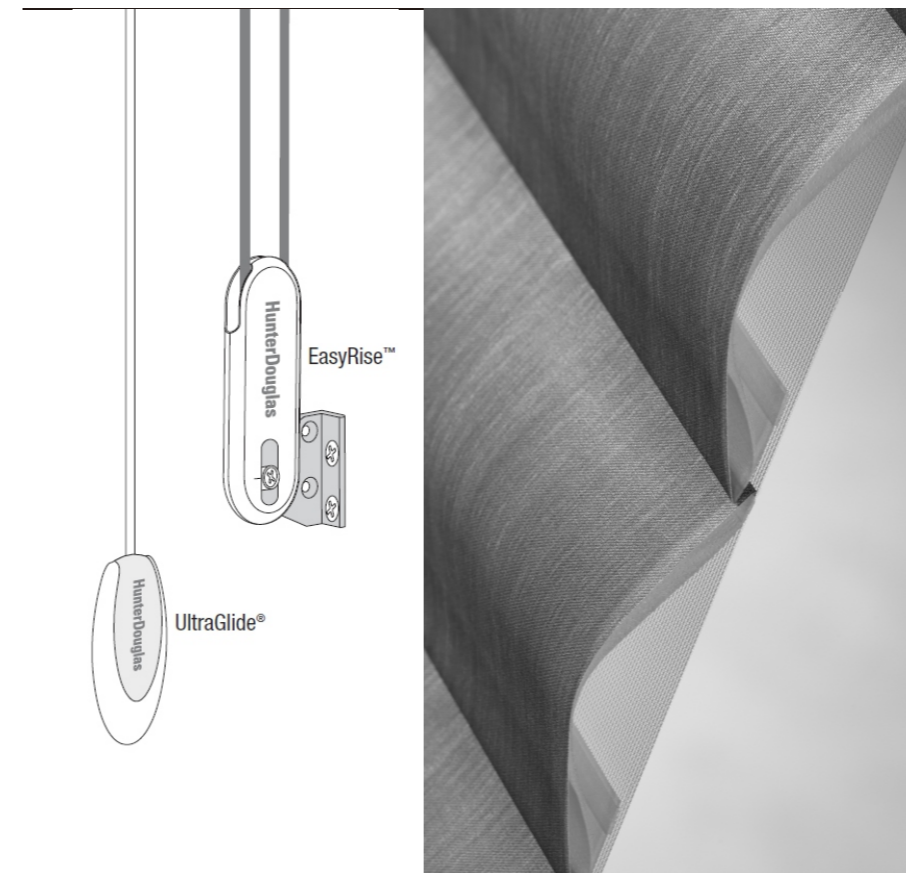

EasyRise™ Shadings

Pull the front or rear cord to raise or lower the shading.
The shading will hold its position when you release the cord.

- To Lower the Shading: Pull down on the rear cord of the cord loop.
- With the shading fully lowered, continue to pull the rear cord to open the vanes.
- To Raise the Shading: With the shading fully lowered, pull down the front cord.

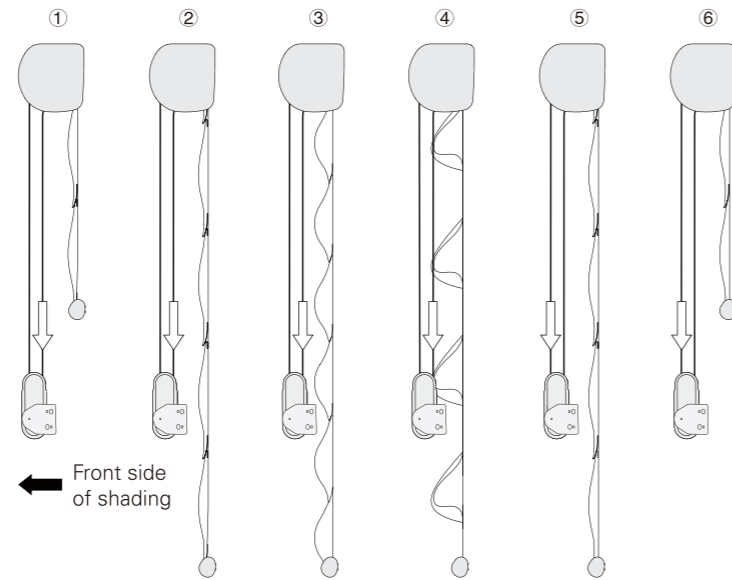

UltraGlide® Shadings

To Lower the Shading

- Pull the cord straight out from the fabric at an angle greater than 25 degrees.
- Pump the cord outward using short strokes to gradually lower the shading.
- To stop the shading in any position, stop pulling the cord and allow it to fully retract. The vanes will remain in the closed position unless the shading is completely lowered.



To Open the Vanes

- Continue to pull out on the cord at an angle greater than 25 degrees after lowering the shading completely.

To Close the Vanes and Raise the Shading

- Hold the cord close to the fabric and pull straight down.
- Pump the cord down using short strokes to gradually raise the shading.

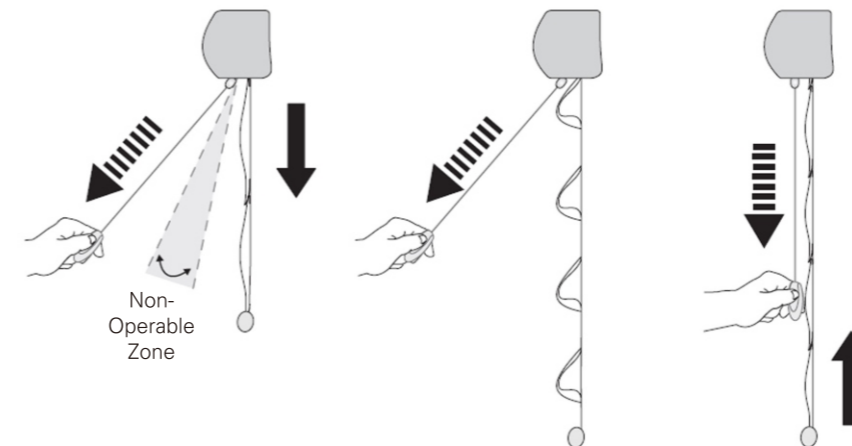

WARNING 

Young children can get STRANGLED in cord loops. They can also wrap cords around their necks and STRANGLE themselves. Always keep cords out of the reach of children. Move cribs, playpens and other furniture away from cords. Children can climb on furniture to get to cords.

Only Hunter Douglas supplied cord tensioners and hardware should be used.



PowerView[®]

Please refer to the User Manual for PowerView operation guide.

THE WHOLE HOUSE SOLUTION™

Along with Pirouette, Hunter Douglas offers a range of matching fabrics in Silhouette, Luminette and Duette, that will help you to create a varied and yet harmonious design for your home.

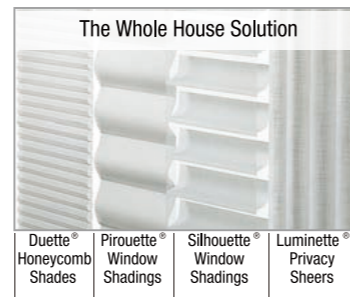

Cleaning Procedures

Pirouette[®] Window Shadings are made of 100% polyester, which means they are inherently durable and resilient. However, care must be taken to avoid wrinkling the fabric, particularly where the vanes meet the sheer backing fabric.

CAUTION: Do not steam Pirouette fabrics.



Fabric-Covered Headrail

- Lightly dust with a clean, dry cloth, vacuum using low suction, or spot clean with a damp cloth and mild detergent.

Dusting

- Regular light dusting with a feather duster is all the cleaning needed in most circumstances.

Vacuuming

- Use hand-held vacuum with low suction, for more thorough dust removal.

Spot Cleaning

- Spot clean with a damp cloth using a mixture of water and mild detergent.

Ultrasonic Cleaning

CAUTION: Do not ultrasonically clean Satin fabrics.

- Other Pirouette window shadings can be ultrasonically cleaned by a professional.
- Specify that a mild detergent solution be used.
- Never immerse the headrail in the solution.
- Dry the shading completely in the lowered position.

Electrostatic Cleaning

- Do not use electrostatic cleaning devices on any Pirouette window shading.



A Note About Pirouette® Fabric

- As with all textiles, Pirouette fabric is subject to some variations. Slight wrinkling, puckering, or bowing is inherent to this textile product and should be considered normal, acceptable quality.
- These characteristics are not usually visible from the front or rear but may be visible from a side angle.
- Precautions should be taken to reduce exposure to harsh environmental elements, such as salt air.
- Continuous exposure through open windows and doors will accelerate fabric deterioration.

Invisi-Lift™

- The revolutionary Invisi-Lift™ system consists of clear strands that operate the horizontal fabric vanes. These strands are quite durable; however, if one or two become broken, the shading will remain functional.

Vanes

- If the vanes stick and do not open properly during initial operation, simply open and close the shading quickly to “shake” the vanes open. Then if necessary, gently pull down on the center of the bottom rail and/or the last vane.
- Do the same quick operation for vanes that are not closing completely, followed by rolling the shading up slowly into the headrail to flatten the vanes.

Light Gap

- In the front of Pirouette shading, vanes are partially overlapping to offer a better light and privacy control.
- Vanes are not designed to completely block light out. There is light gap between vanes.
- The sides show light gaps at both sides for inside mounting, 17mm on the control side and 11mm on the other side.

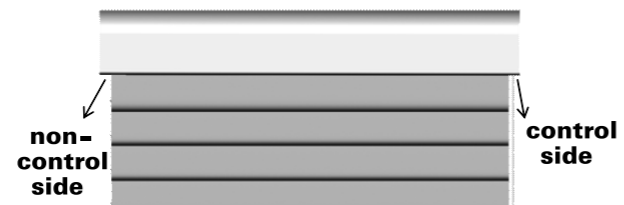

Silhouette®

Window Shadings

EasyRise™ UltraGlide®

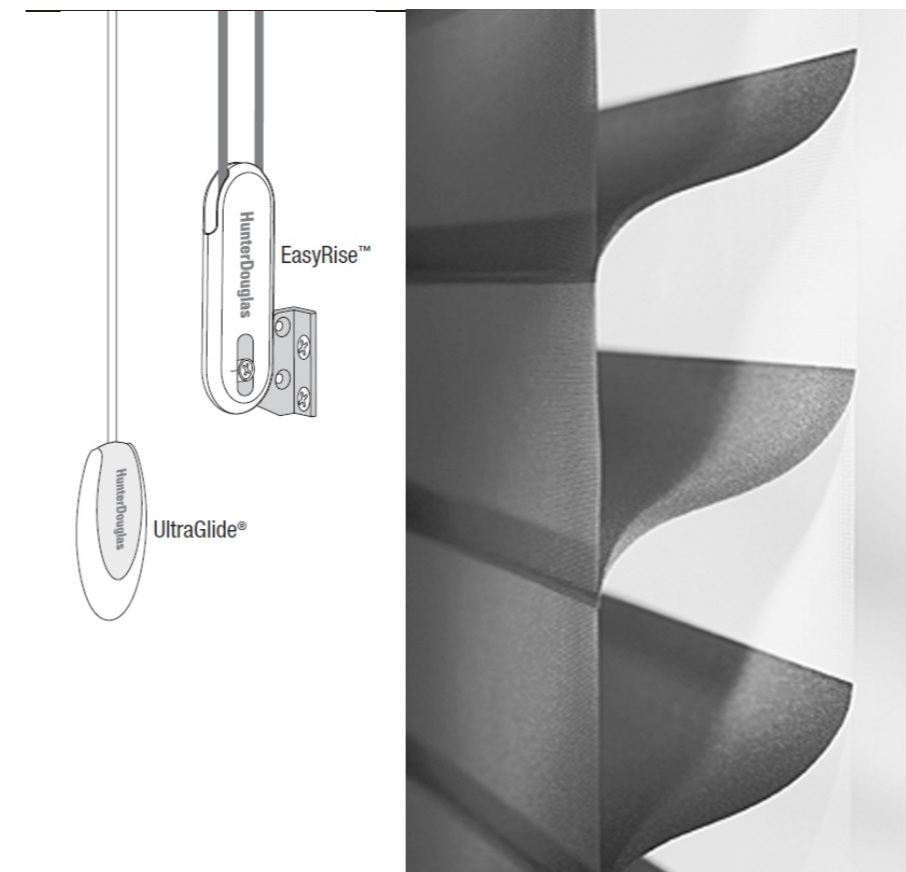

EasyRise™ Shadings

To Lower the Shading and Open the Vanes

- Pull the rear cord of the cord loop down to lower the shading.
- With the shading fully lowered, continue to pull the rear cord to tilt the bottom rail and open the vanes.
- If the cord tensioner moves up the cord, you have not secured it to the wall or window frame. You must do so for the shading to operate properly.

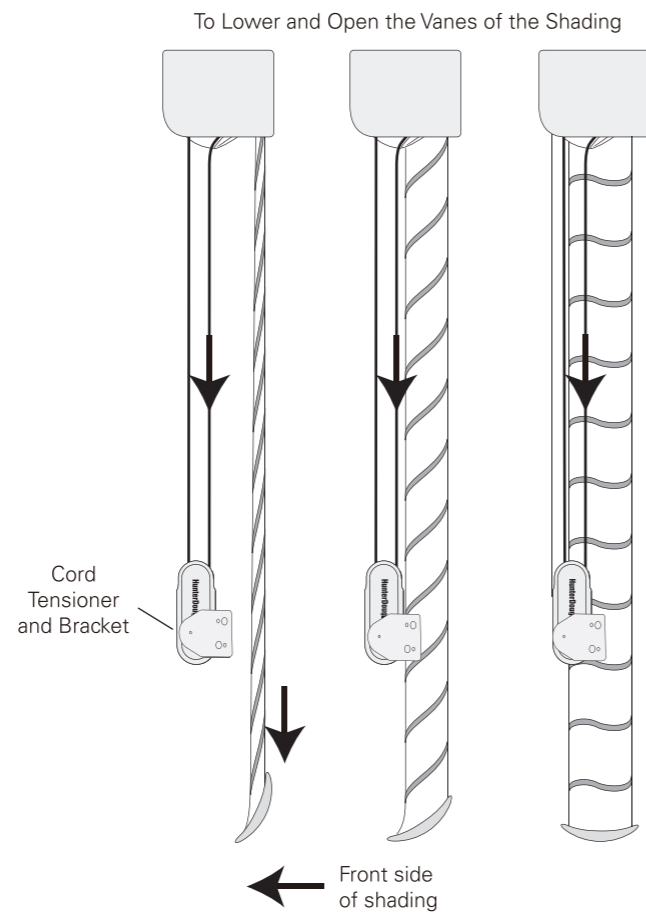

To Close the Vanes and Raise the Shading

- Pull the front cord of the cord loop down to close the vanes and raise the shading.
- If the cord tensioner moves up the cord, you have not secured it to the wall or window frame. You must do so for the shading to operate properly.

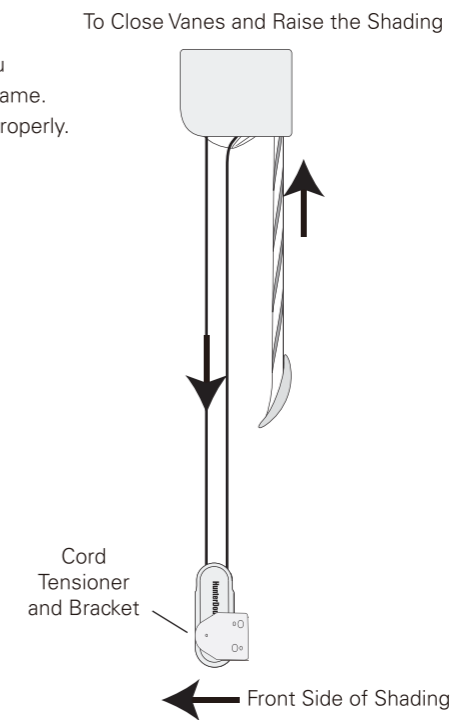

UltraGlide® Shadings

To Lower the Shading and Open the Vanes

- Pull the cord toward the center of the shading. Listen for a “click” and then release the cord.
- The vanes automatically open once the shading is completely lowered.
- The shading can be stopped at any point while lowering by slightly tugging the cord straight down.

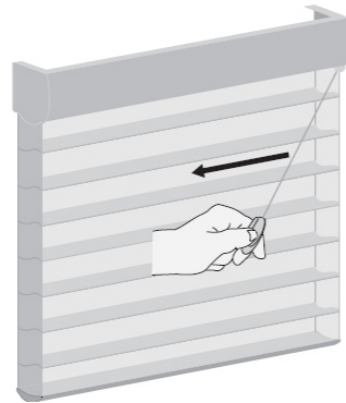

To Tilt the Vanes and Raise the Shading

- Pull the cord with shorter strokes to tilt the vanes.
- Pull the cord straight down with long strokes.
- With each stroke the vanes close or the shading partially raises.
- Allow the cord to retract completely into the headrail after each downward stroke.
- The shading can be stopped at any point while raising.

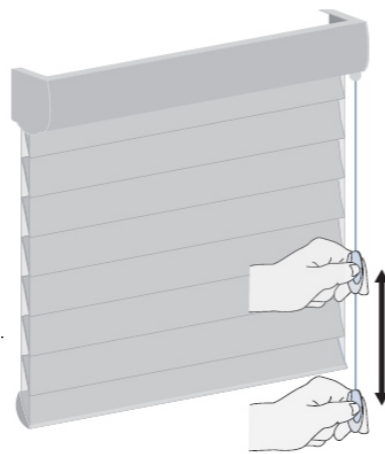

WARNING 

Young children can get STRANGLED in cord loops. They can also wrap cords around their necks and STRANGLE themselves. Always keep cords out of the reach of children. Move cribs, playpens and other furniture away from cords. Children can climb on furniture to get to cords.



Only Hunter Douglas supplied cord tensioners and hardware should be used.

PowerView®

Please refer to the User Manual for PowerView operation guide.

THE WHOLE HOUSE SOLUTION™

Along with Silhouette, Hunter Douglas offers a range of matching fabrics in Pirouette, Luminette and Duette, that will help you to create a varied and yet harmonious design for your home.

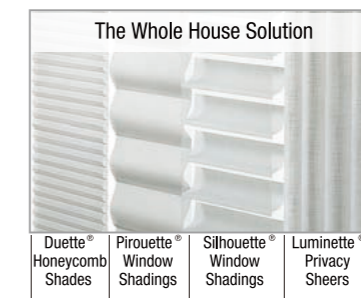

Cleaning Procedures

Silhouette® Window Shadings are made of 100% polyester, which means they are inherently durable and resilient. However, care must be taken to avoid wrinkling the fabric, particularly where the vanes meet the facings.

Dusting

- Regular light dusting with a feather duster is all the cleaning needed in most circumstances.



Vacuuuming

- Use hand-held vacuum with low suction, for more thorough dust removal.



Forced Air

- Blow away dirt and debris between the vanes using clean compressed air.



Spot Cleaning

- Spot clean with a damp cloth using a mixture of water and mild detergent.

Ultrasonic Cleaning (professional)

- Most Silhouette® fabrics can be cleaned ultrasonically by a professional.
- Specify that a mild detergent solution be used.
- Never immerse the headrail in the solution.

Injection/Extraction

- Use only the dry method of injection/extraction for all Bon Soir fabrics, Misty Harbor, and Traditions Light Dimming.
- Never immerse the headrail in the solution.

A Note About Silhouette Fabric

- As with all textiles, Silhouette fabrics are subject to some variations. Slight wrinkling, puckering, or bowing is inherent to this textile product and should be considered normal, acceptable quality.
- These characteristics are not usually visible from the front or rear but may be visible from a side angle.
- Precautions should be taken to reduce exposure to harsh environmental elements, such as salt air.
- Continuous exposure through open windows and doors will accelerate fabric deterioration.

Puckers

- Silhouette® Window Shadings are highly engineered textiles, but like any fabric, there are some visible variations, which are normal and not product defects.



Worn Tracks

- Worm tracks may appear as slight creases that travel horizontally near the front of the vane, typically seen on the face sheer. Left down and open, the sun's heat may reduce such creases.

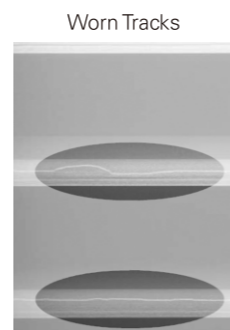

Wrinkles

- Wrinkles may appear as slight depressions in the fabric surface, and in the evening, with the vanes closed, reflective light may show slight puckers in the fabric.

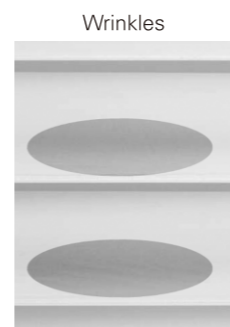

- Slight waviness in the vane material maybe visible when the vanes are open and light passes through the shading ①
- Slight wrinkles in the vane material maybe visible when the vanes are closed ②

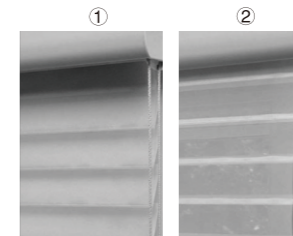

Bottom Rail

- Silhouette® 3" vanes are narrowing at the bottom; and the bottom rail will tilt back when the vanes are open. This is normal status ③

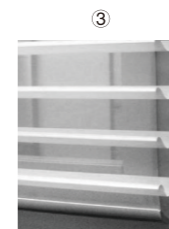

Light Gap

- Due to their dimensionality, Silhouette vanes are not designed to close tightly. This is most noticeable at the bottom of the shadings.
- The closure of vanes tends to be better at the top than at the bottom. The difference is usually more obvious for higher drops.
- For sensitive requirement on room-darkening, you can choose Duette or Roller blind to match with Silhouette.

Vane Closure Tolerances (Maximums)

	3"vane (Silhouette)	3"vane (Nantucket)
Drop ≤ 2438mm	25mm	16mm
Drop > 2438mm	25mm	22mm





HunterDouglas 